

AYGO X

Side Sills

Installation Instructions

Model year: As from 2021/09

Vehicle code: KGB70*-AH**KW
MABH10*-AHX*BW

Part number: PW156-0H010-01 (Chrome)
PW156-0H101-DC (Red)
PW156-0H201-**

Manual reference number: AIM 006 121-6

**Latest Version
SCAN HERE**



CLICK TO NAVIGATE

REVISION RECORD



Page

3

KIT CONTENT



Page

4

TOOLS



Page

4

CONSUMABLES



Page

4

PERSONAL PROTECTION EQUIPMENT



Page

4

GENERAL



Page

5

USEFUL GENERAL MANUALS



Page

5

INSTALLATION INSTRUCTIONS



Pages

6 - 13

INFORMATION



Page

14

CHECK SHEET



Pages

15 - 17



Revision Record

Rev. No.	Date	Page	Step	Remarks
3	26.10.2023			Updated to latest Standards.
4	19.02.2025			Updated to latest Standards.
4	19.02.2025	1, 4	Kit	Vehicle code & Part number added.
5	29.07.2025			Updated to latest Standards.
6	04.09.2025	1		Vehicle code updated.

KIT CONTENT

PW156-0H010-01 (Chrome)
 PW156-0H101-DC (Red)
 PW156-0H201-**



LHS PW156-0H011-01 (Chrome)
 PW156-0H111-DC (Red)

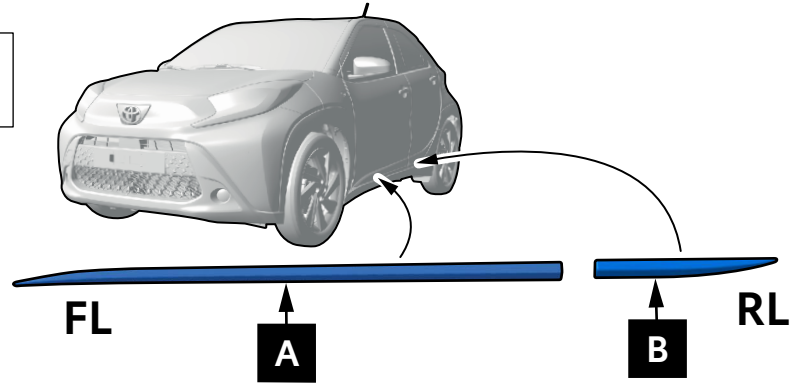

RHS PW156-0H012-01 (Chrome)
 PW156-0H121-DC (Red)

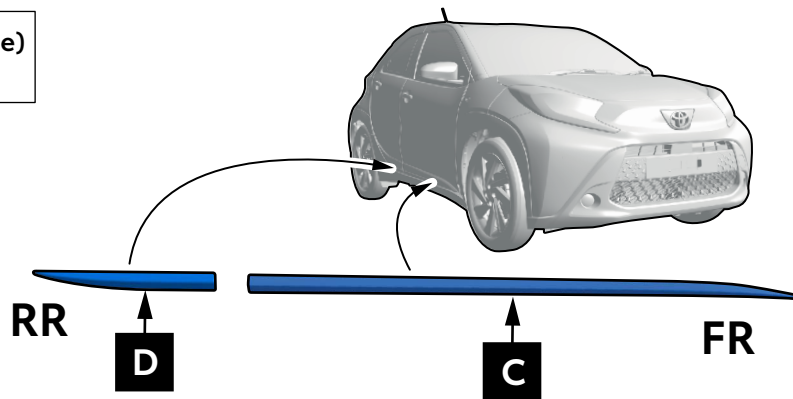

TOOLS

PRESSURE ROLLER	TAPE MEASURE RETRACTABLE	TEMPERATURE SENSOR	RULER	CREDIT CARD

CONSUMABLES

CLEANER / DEGREASER SPRAY	MICROFIBER CLOTH			

PERSONAL PROTECTION EQUIPMENT

PROTECTIVE GLOVES	SAFETY SHOES			

GENERAL

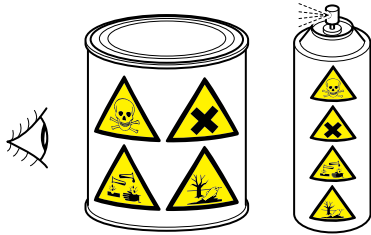

Material Safety Data Sheet



Technical Data Sheet

GENERAL

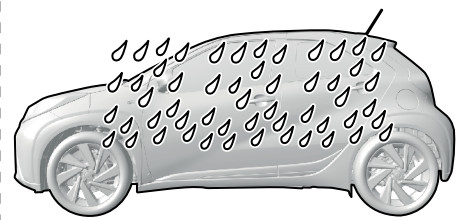
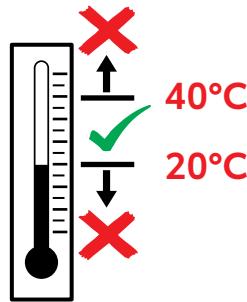
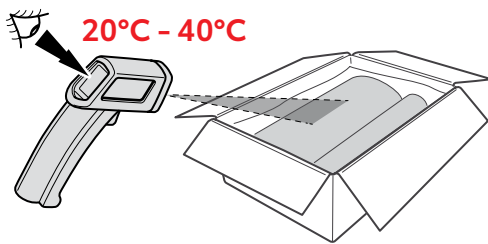
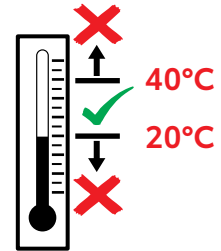
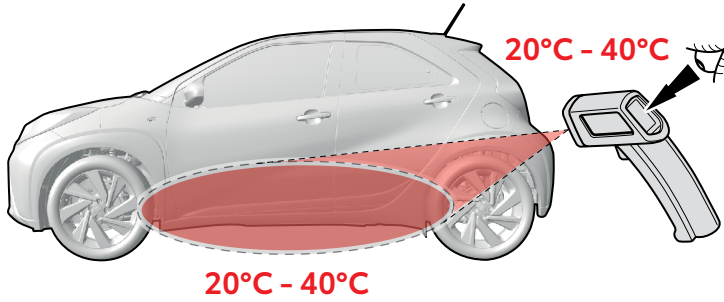

USEFUL GENERAL MANUALS

CLEANER / DEGREASER



Latest Version
SCAN HERE

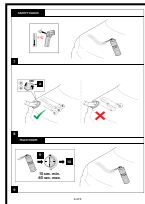

SYMBOLS



Latest Version
SCAN HERE



INSTALLATION CONDITIONS



Latest Version
SCAN HERE



INSTALLATION INSTRUCTIONS

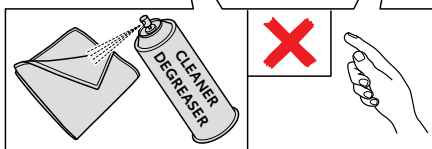
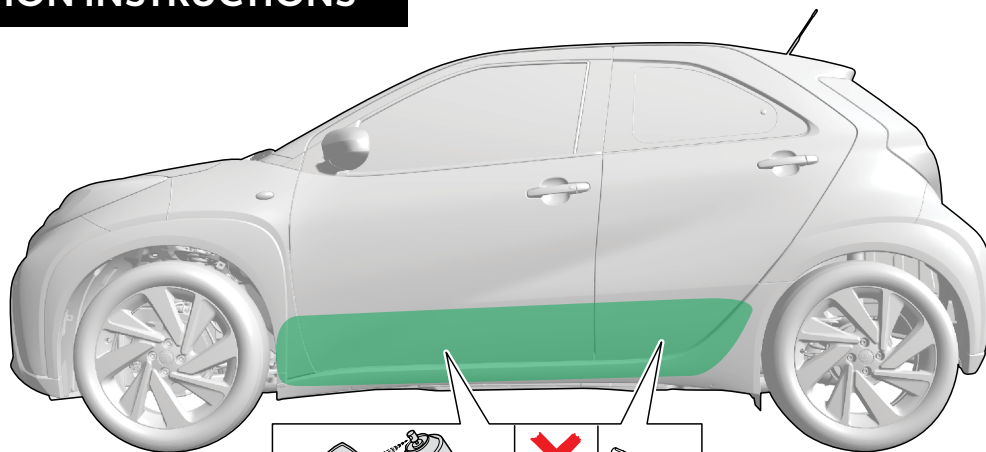

1

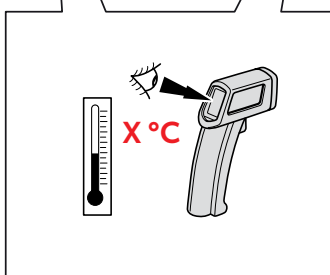
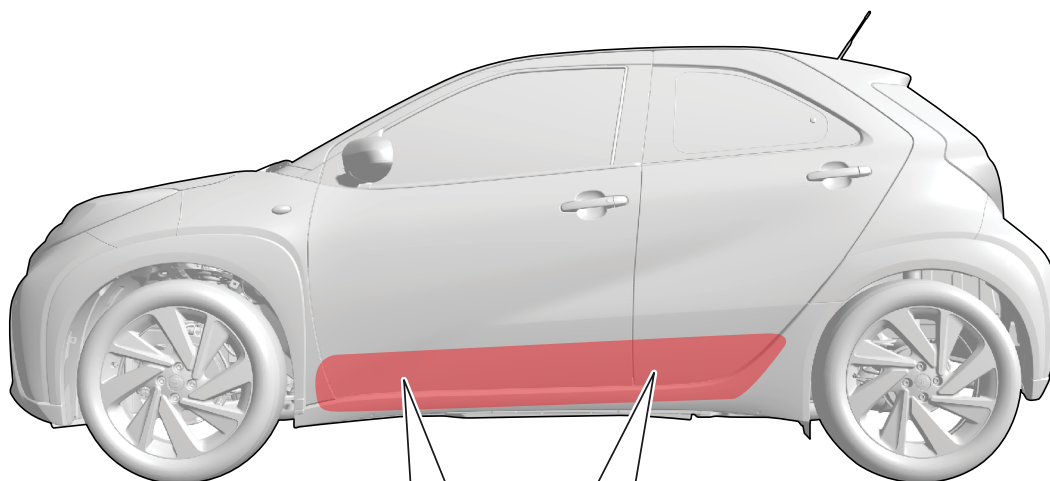

2

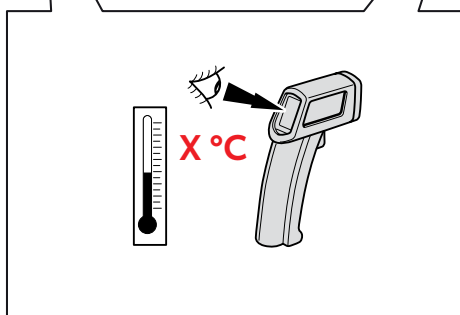
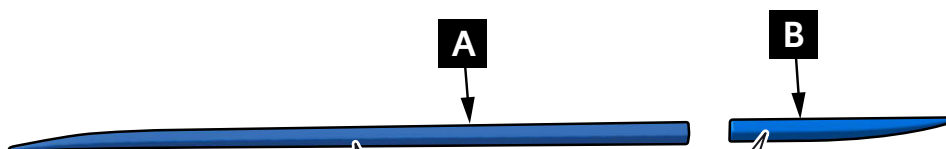

3

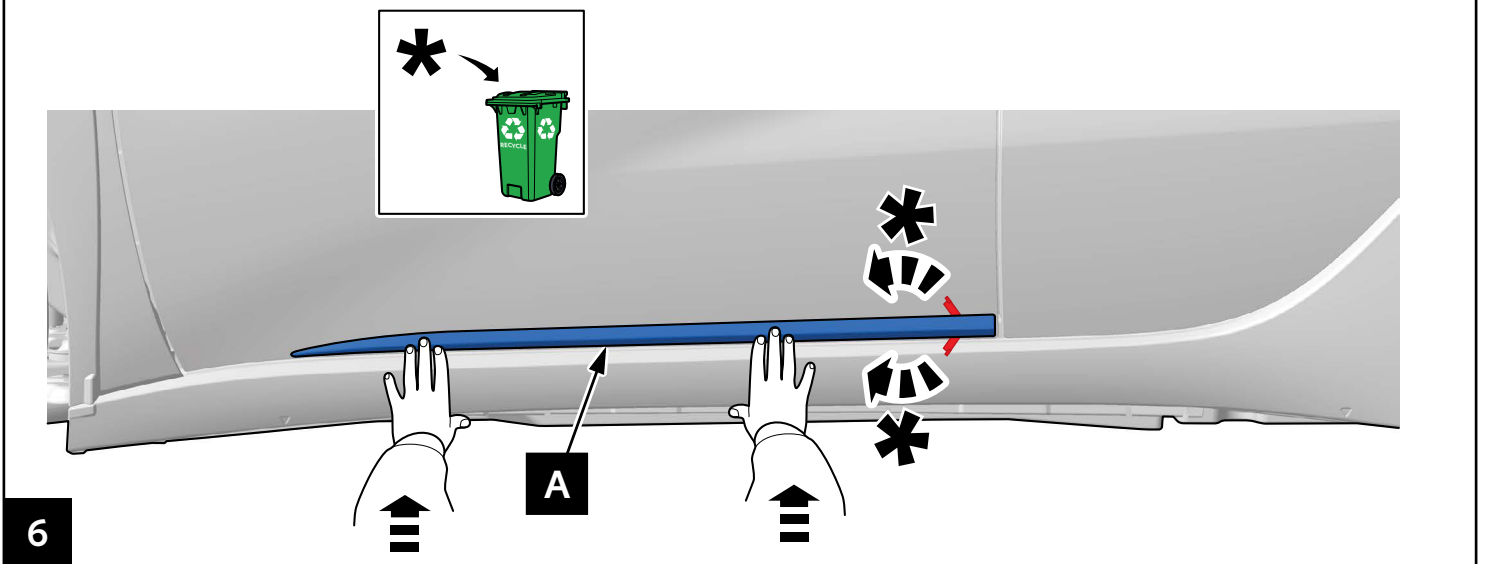
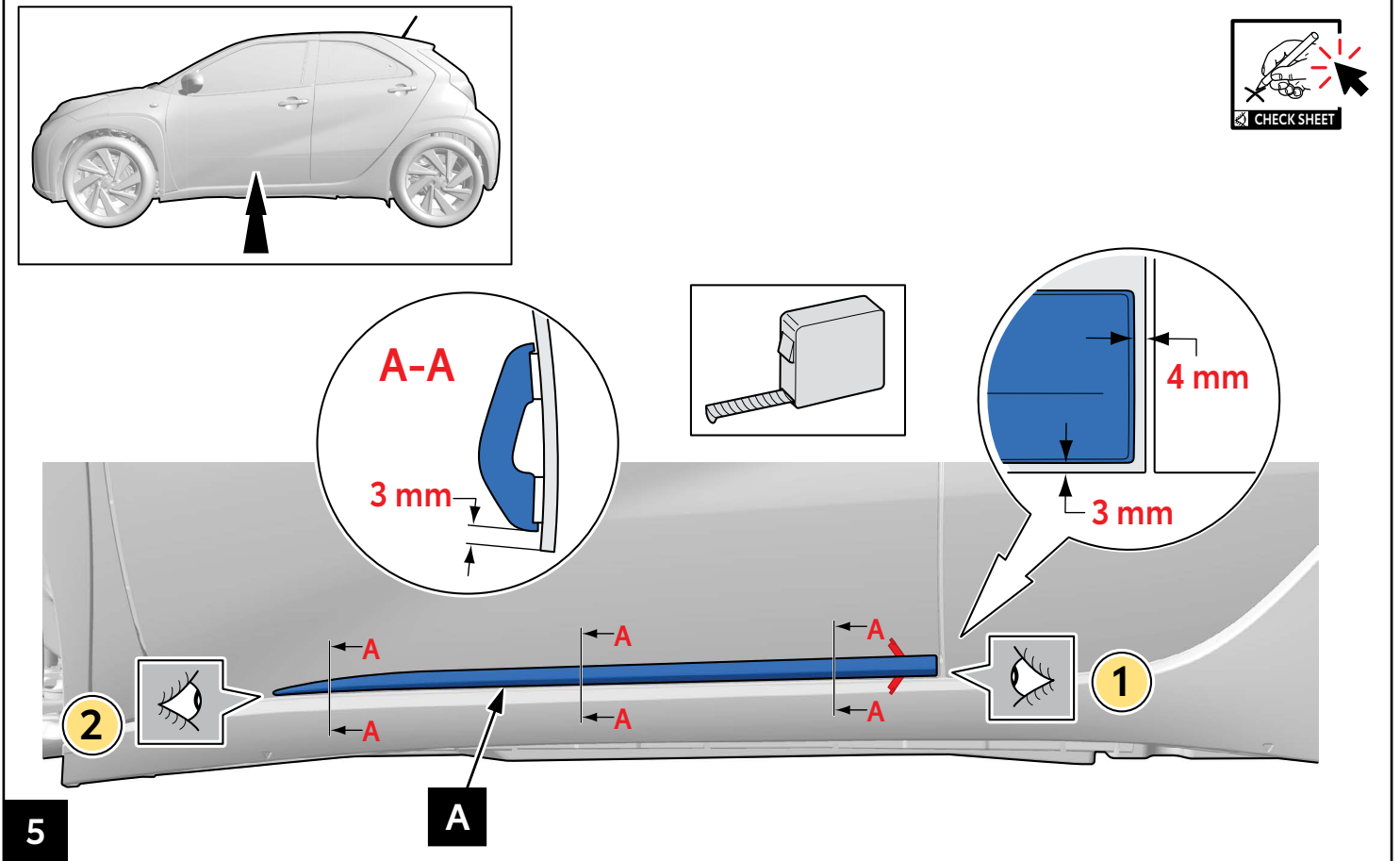
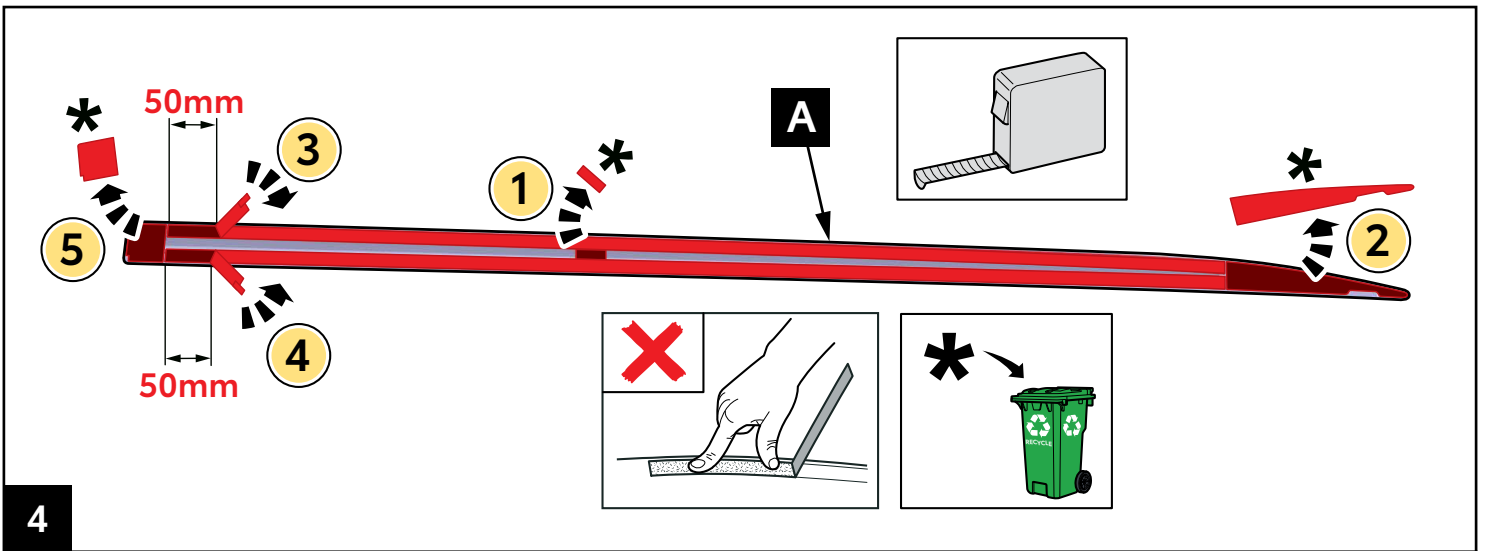

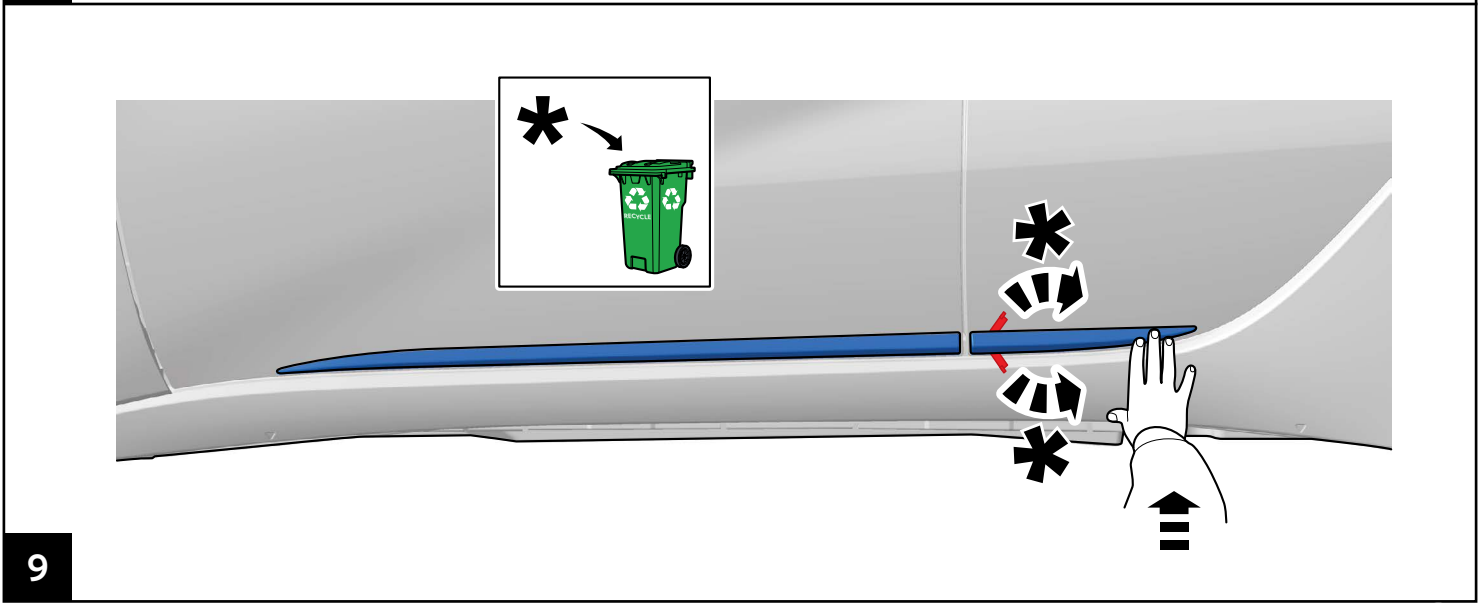
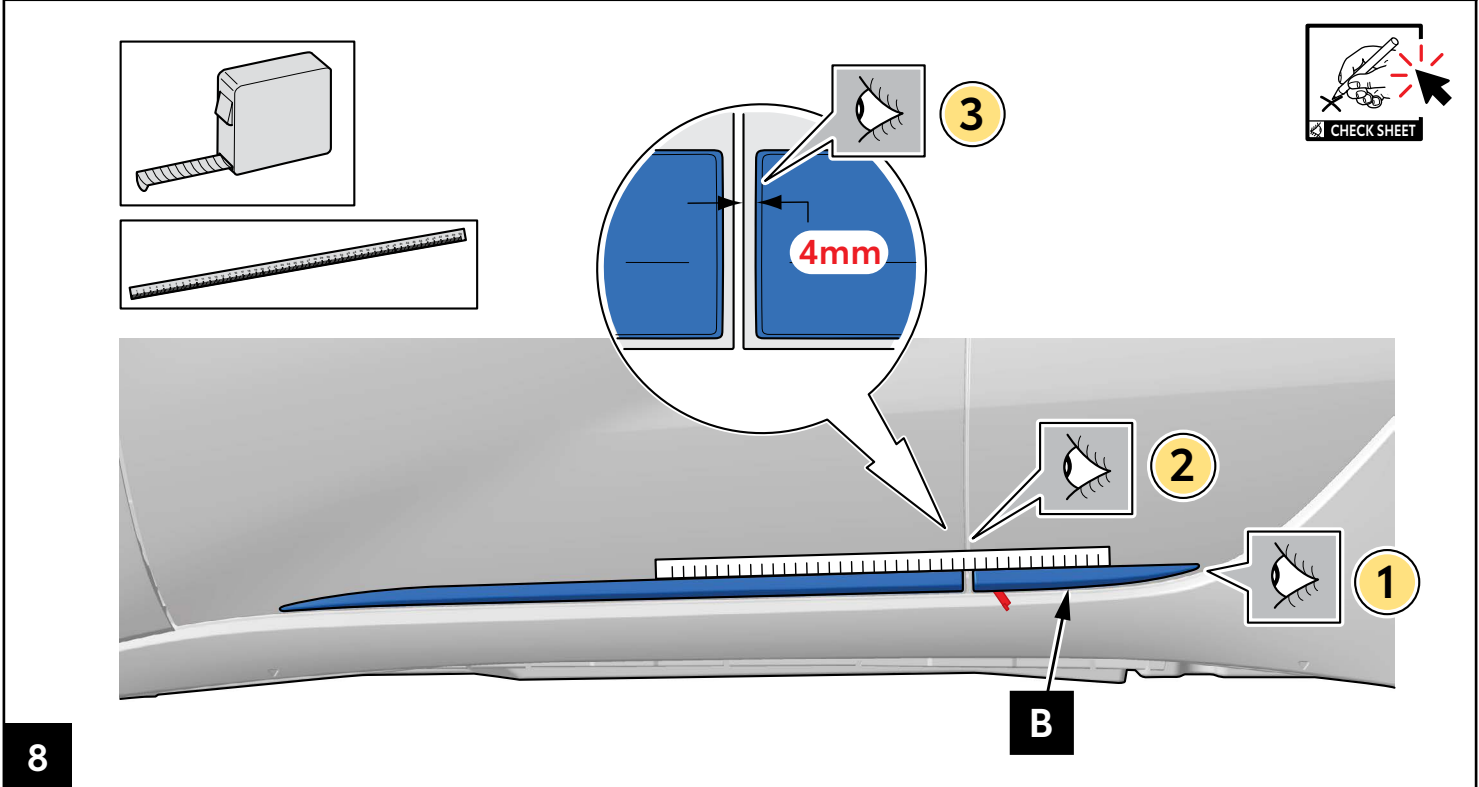
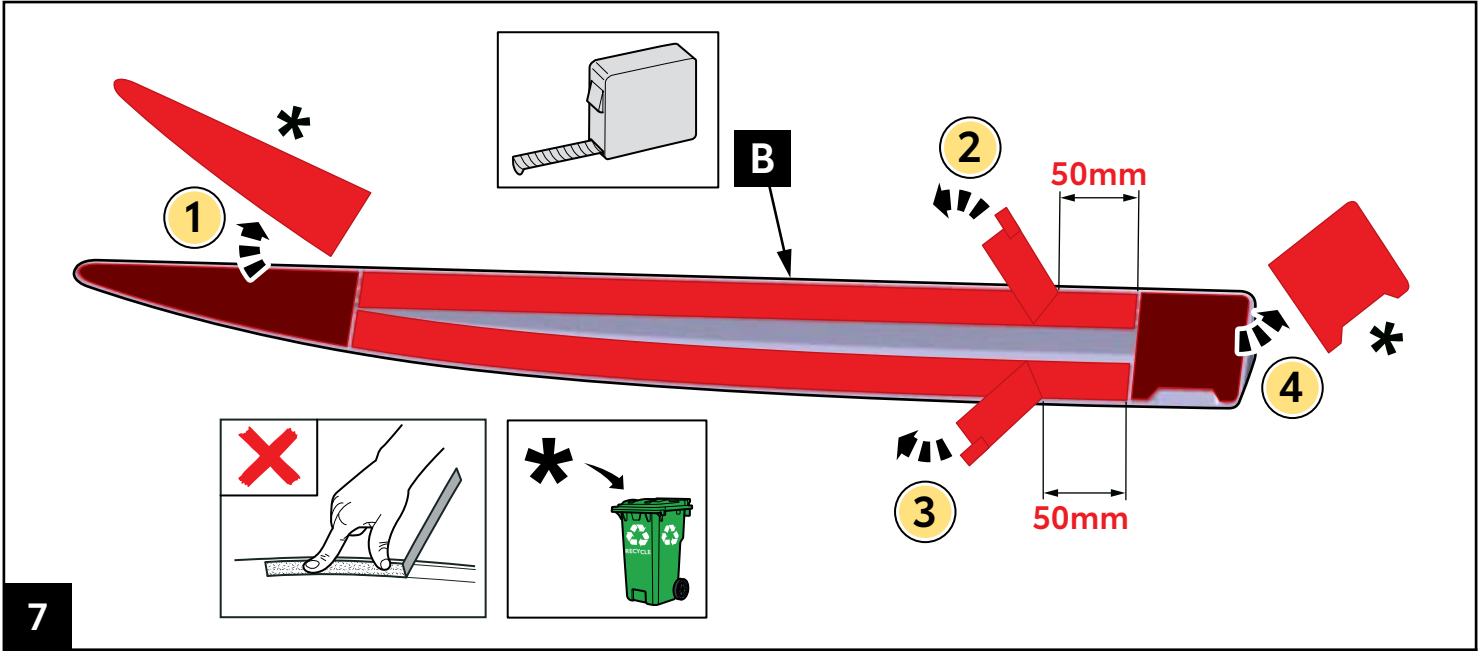

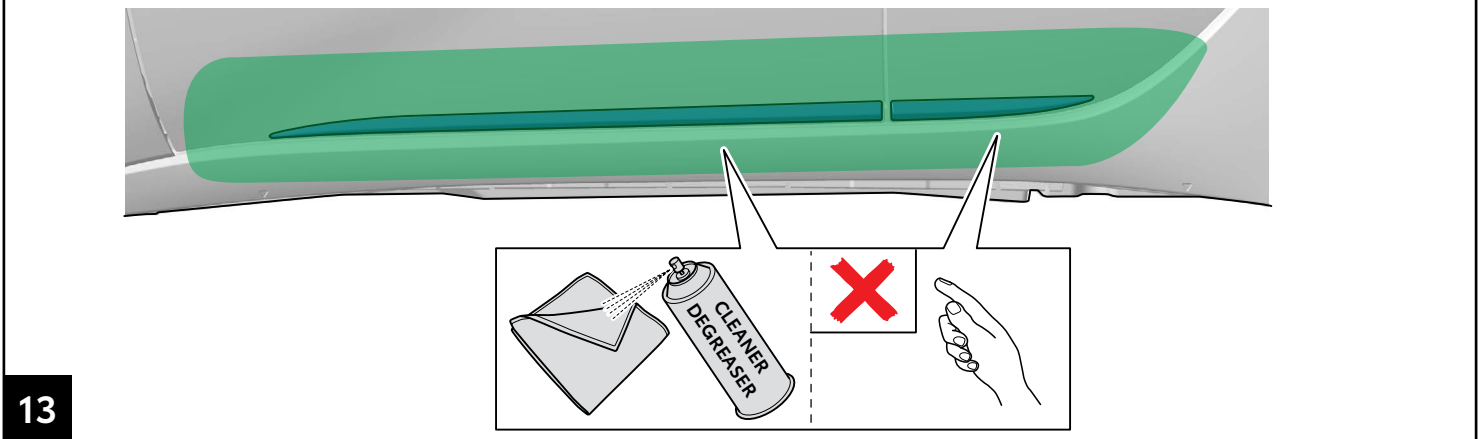
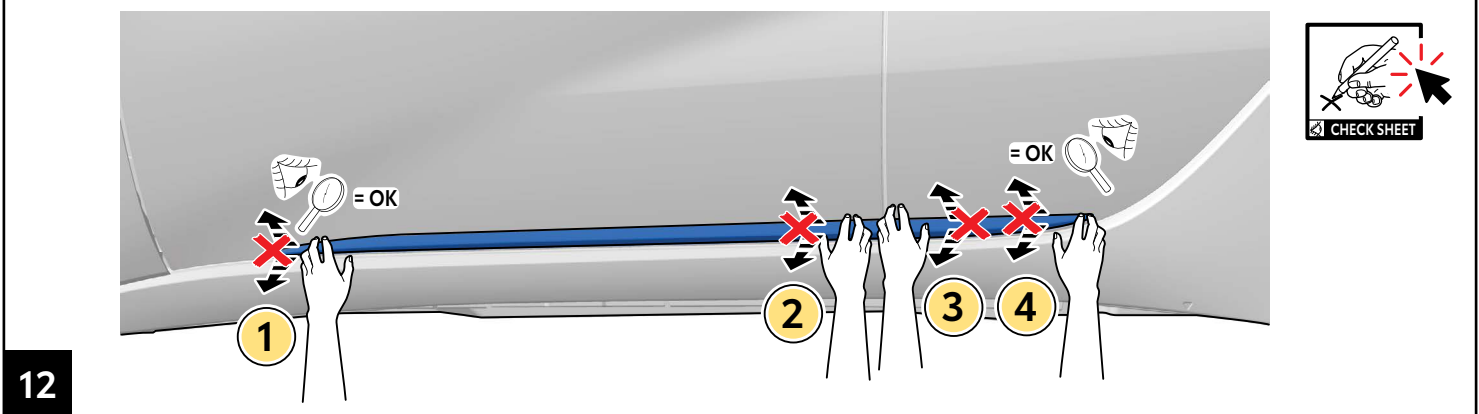
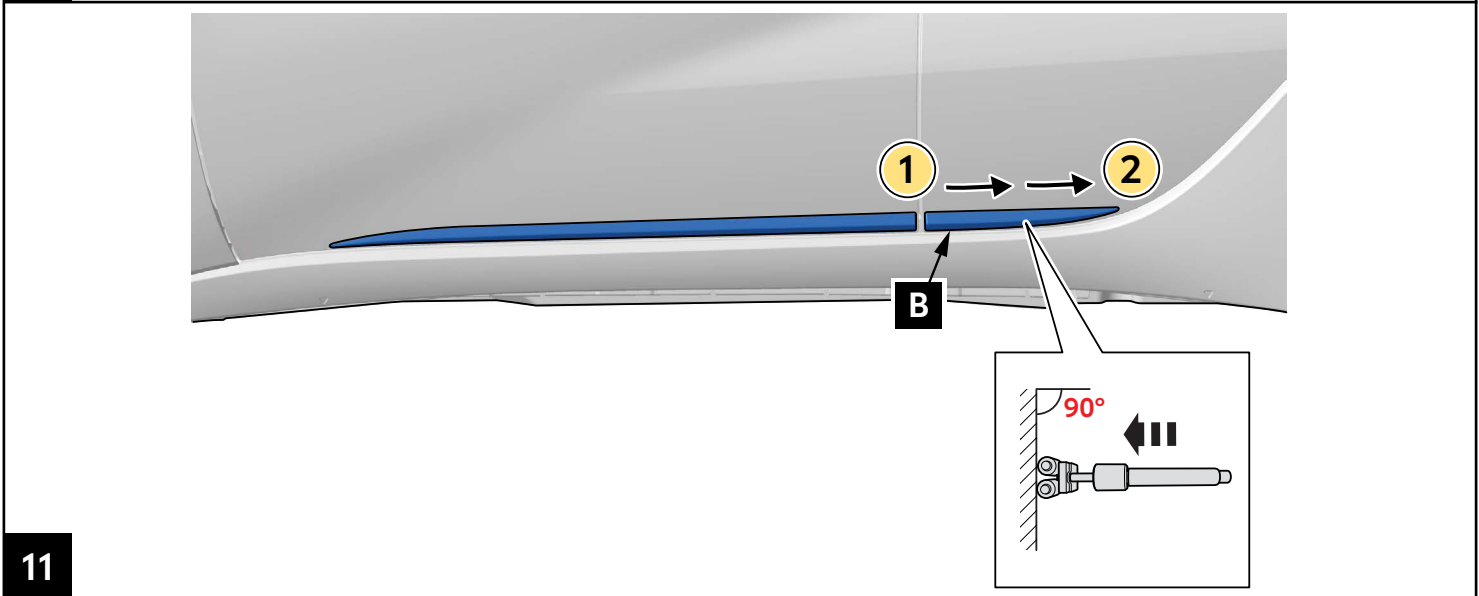
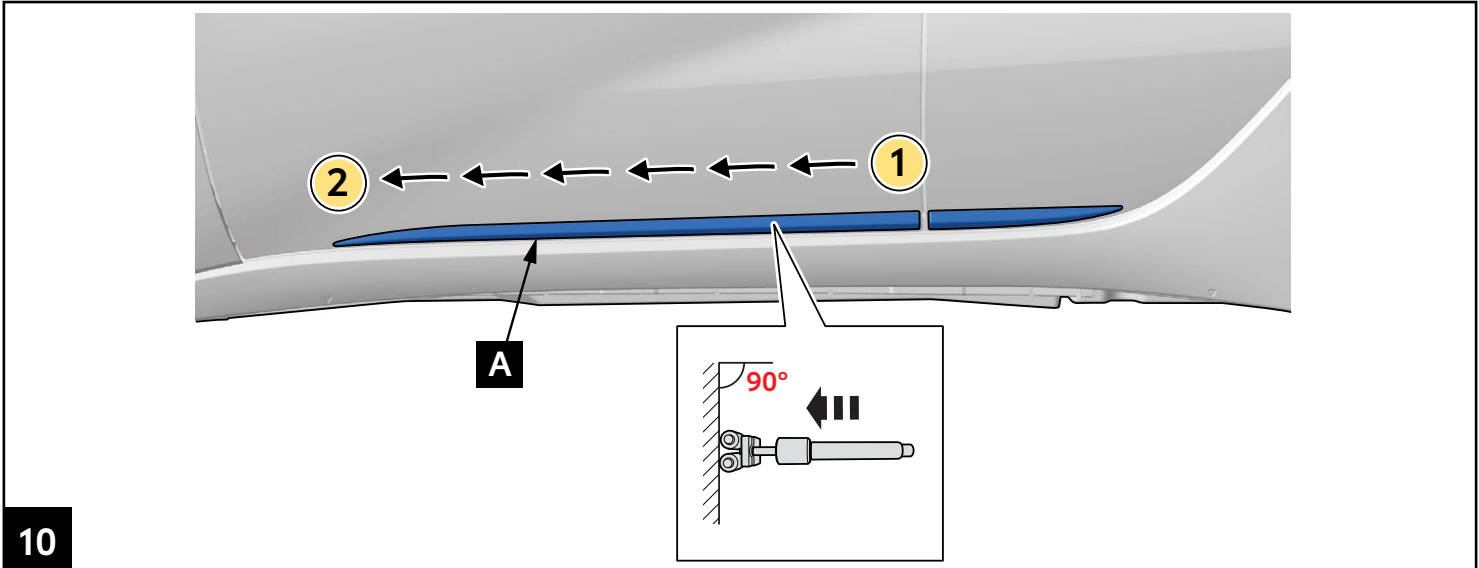

14

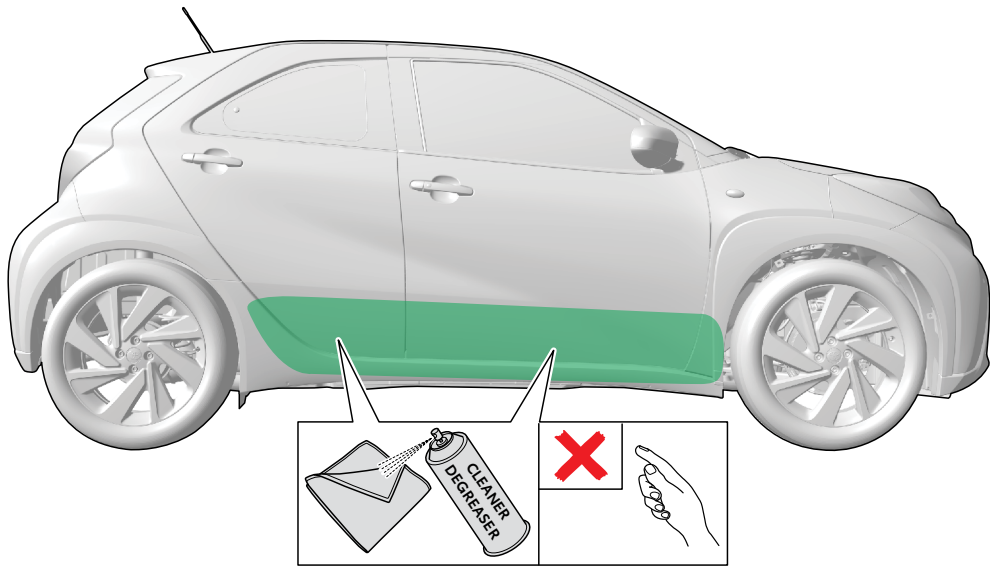

15

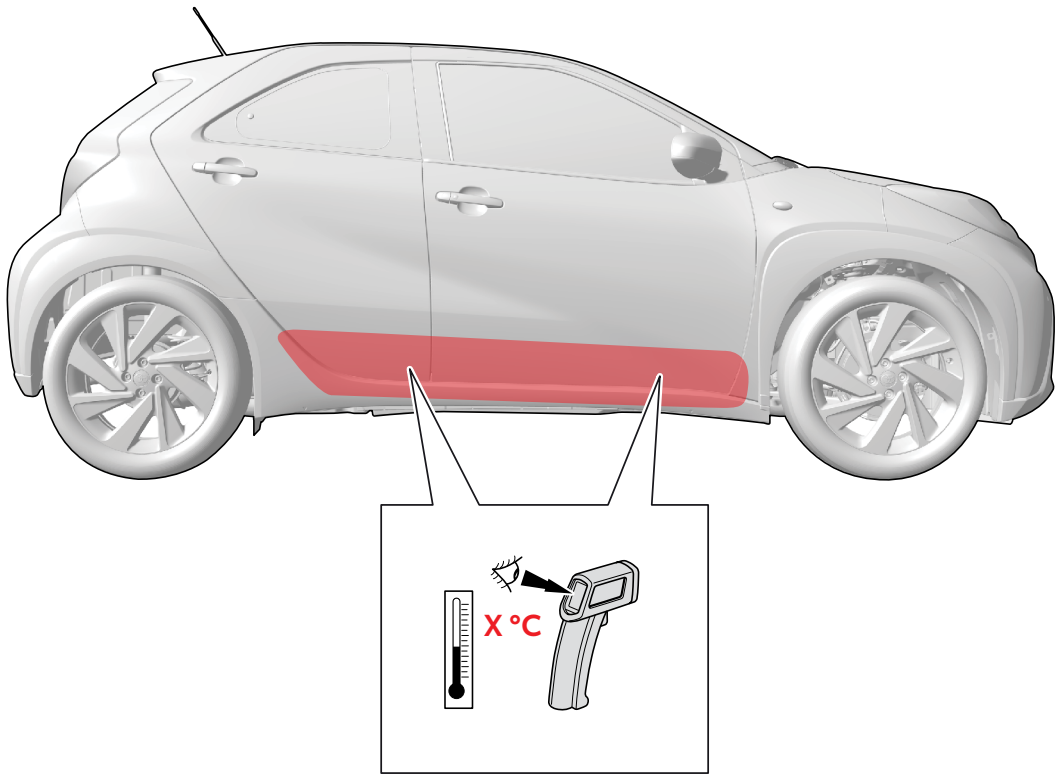

16

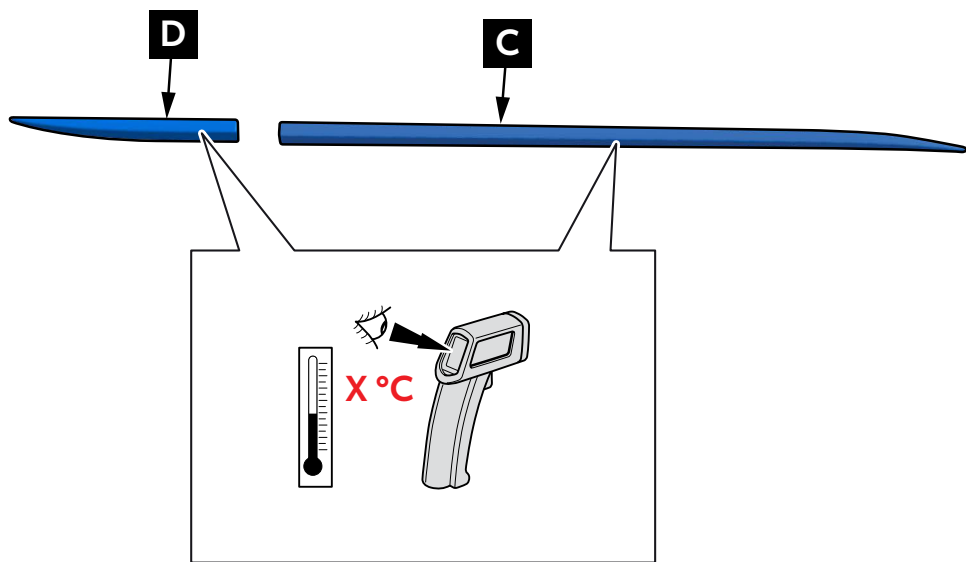

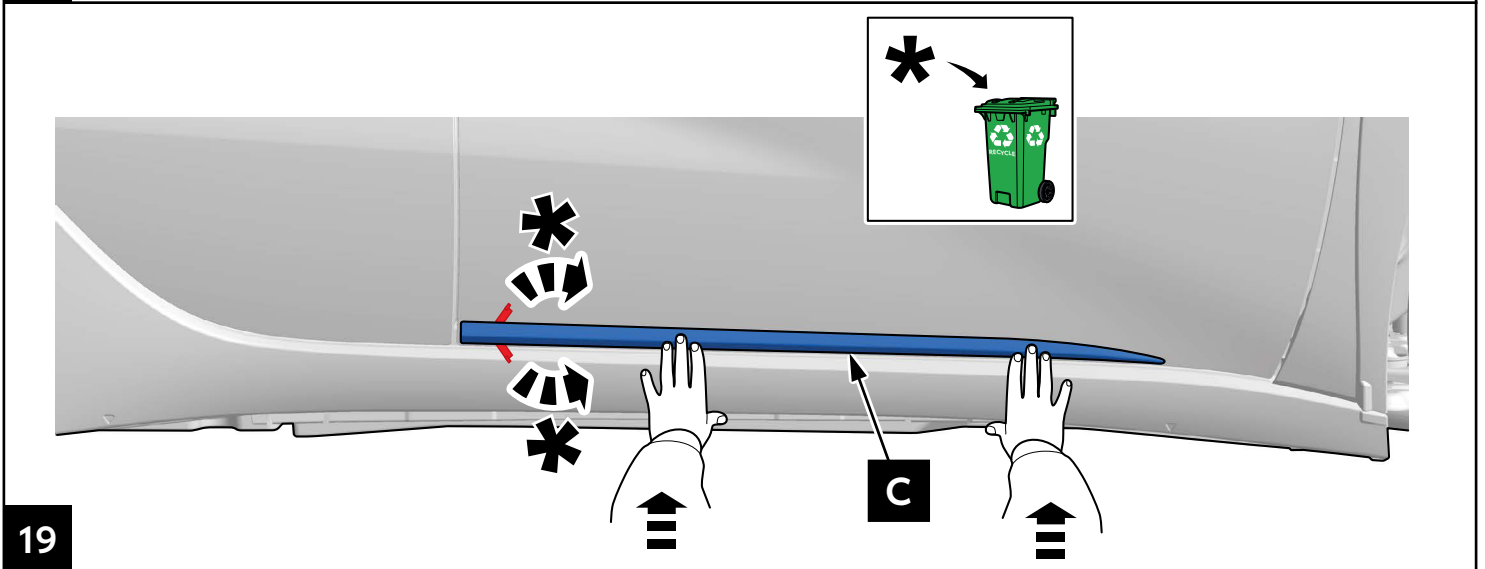
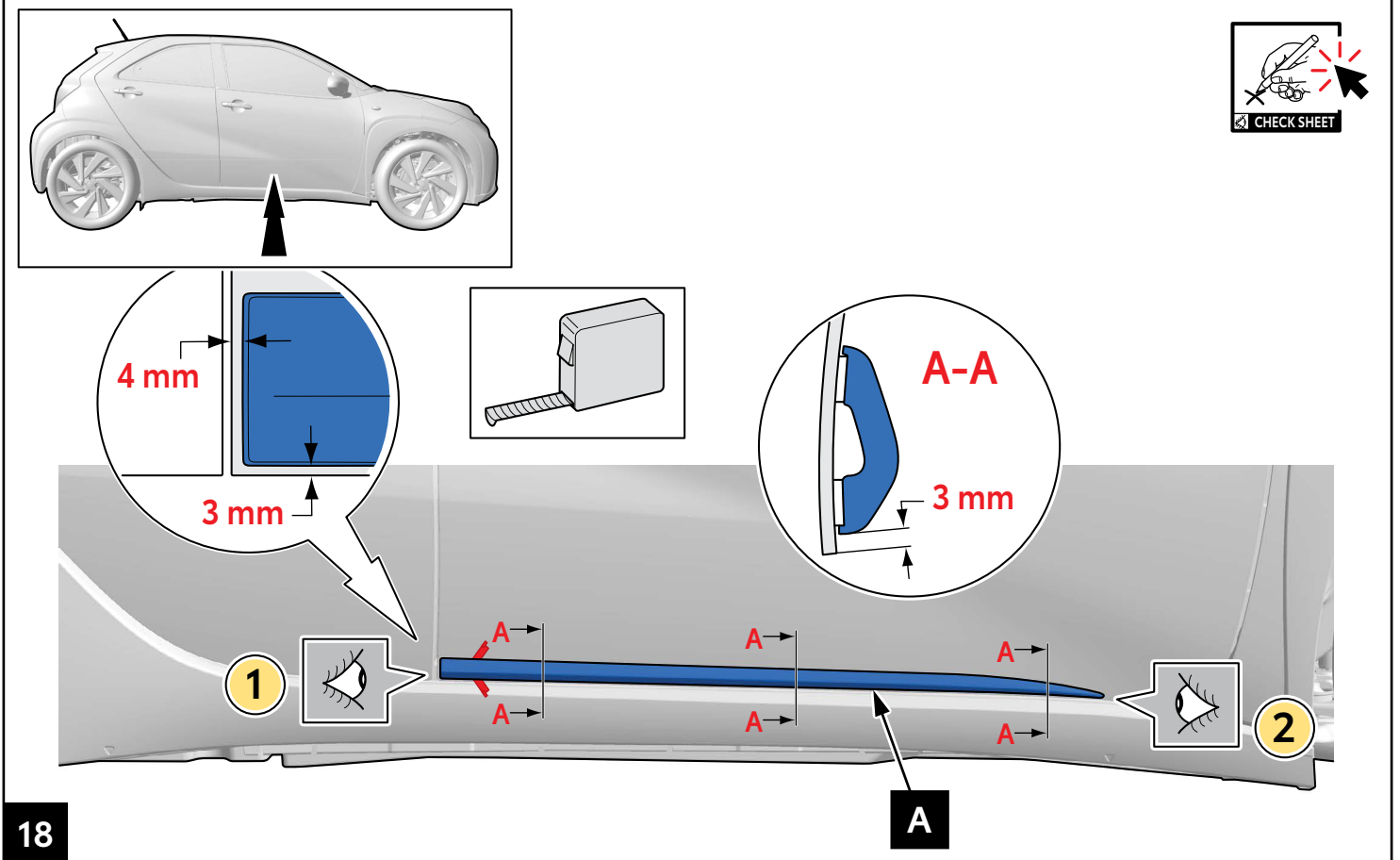
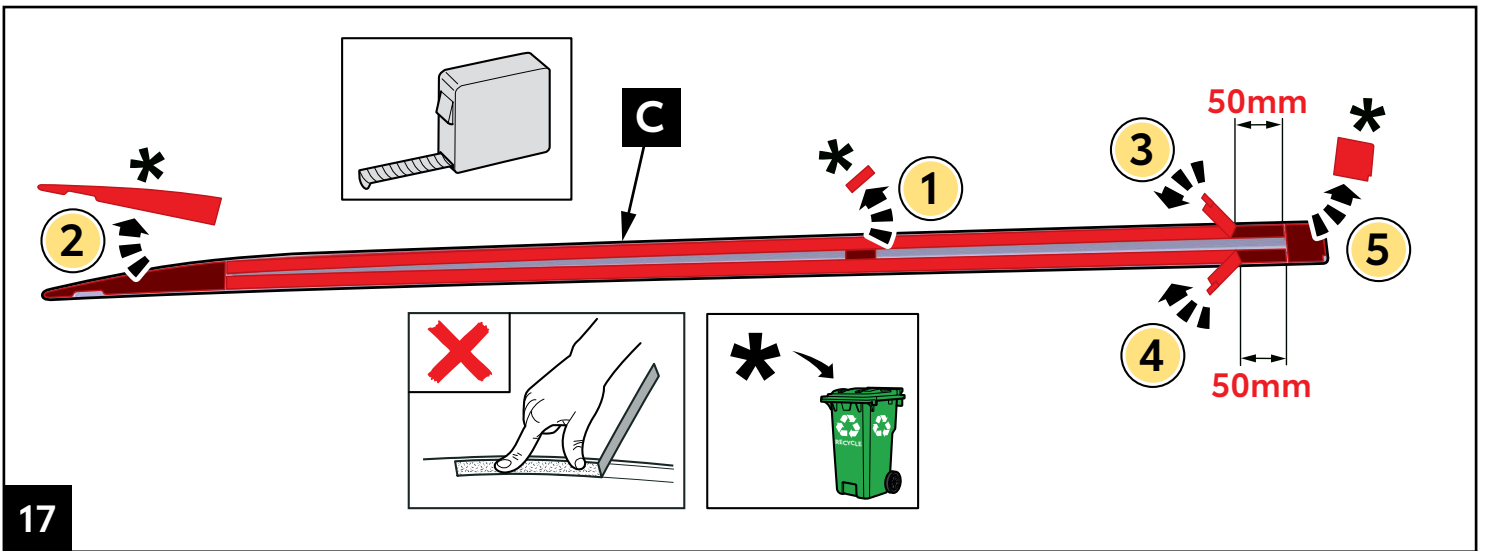

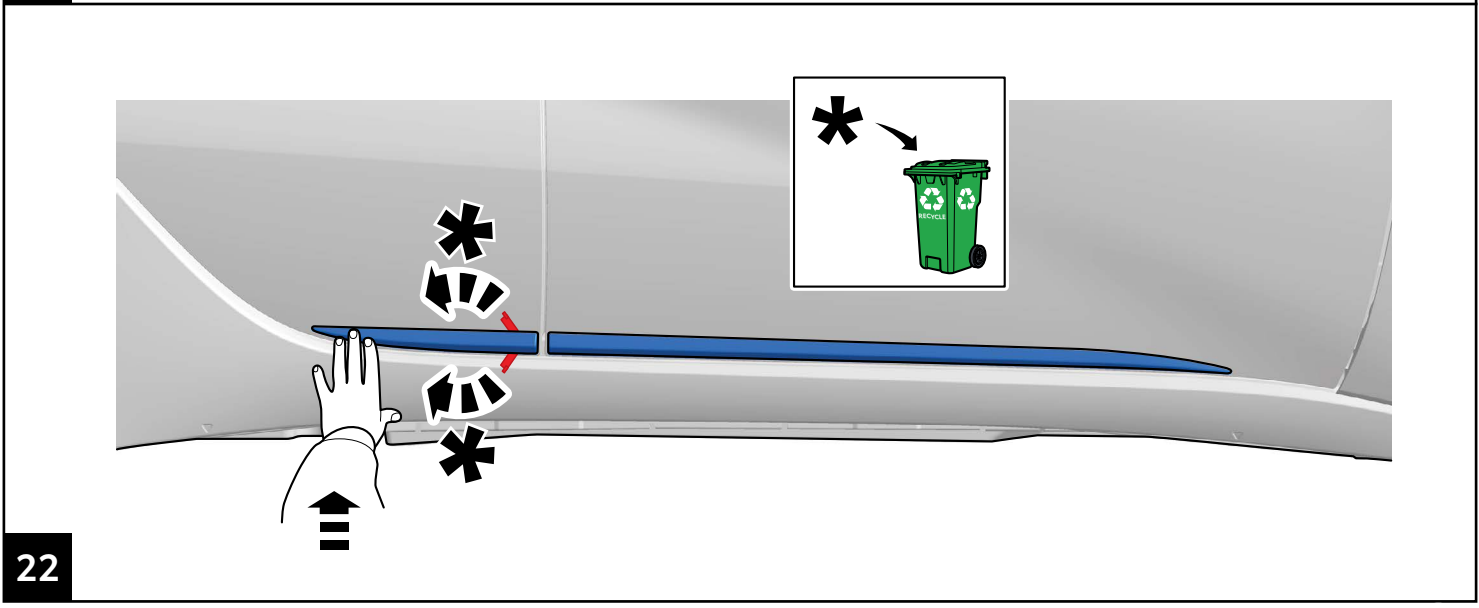
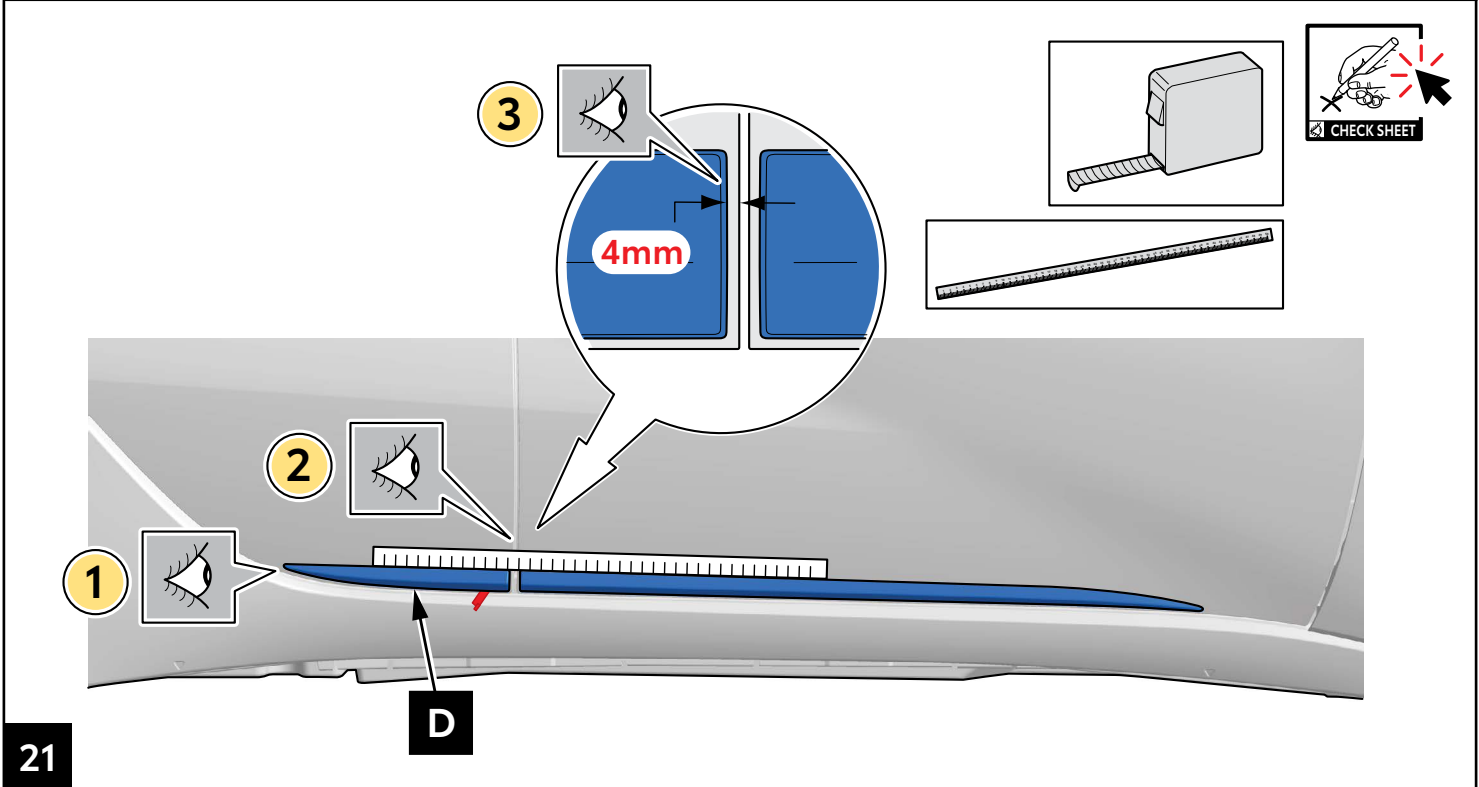
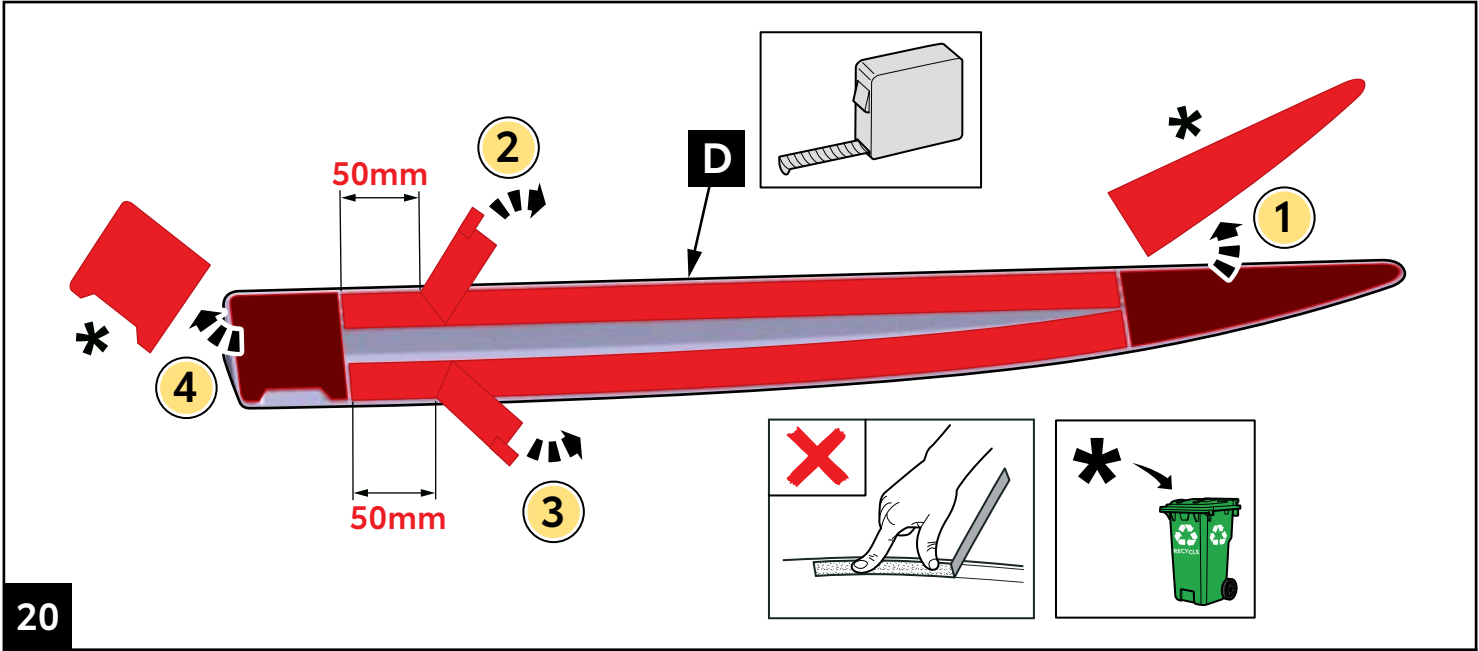

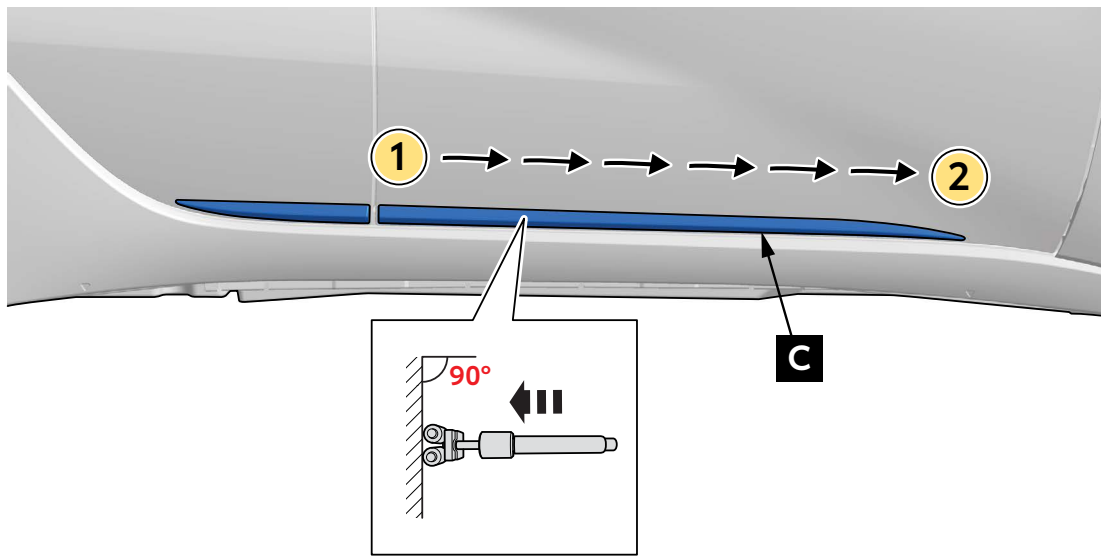

23

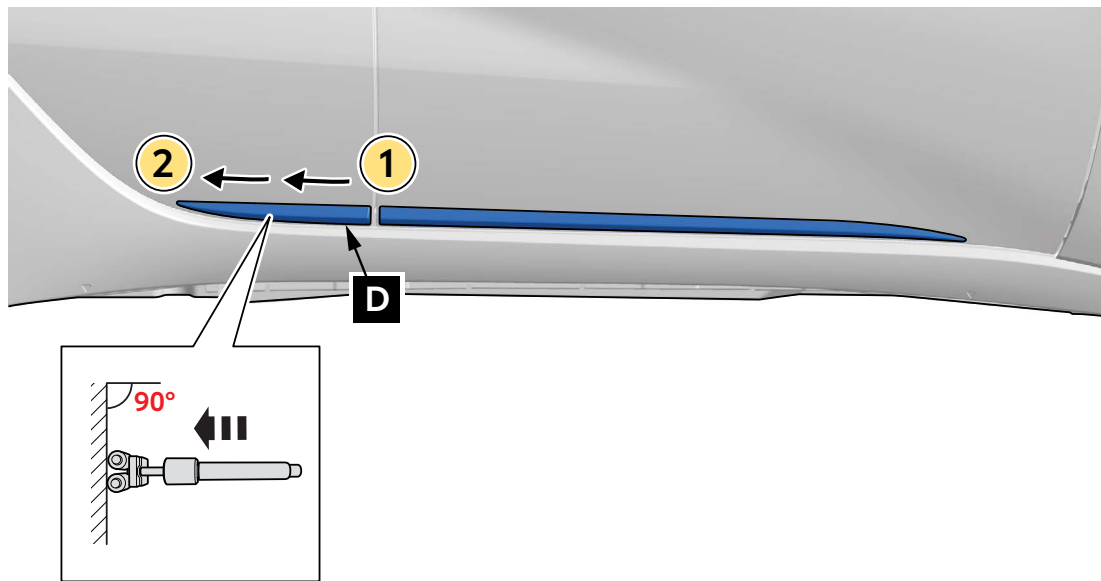

24

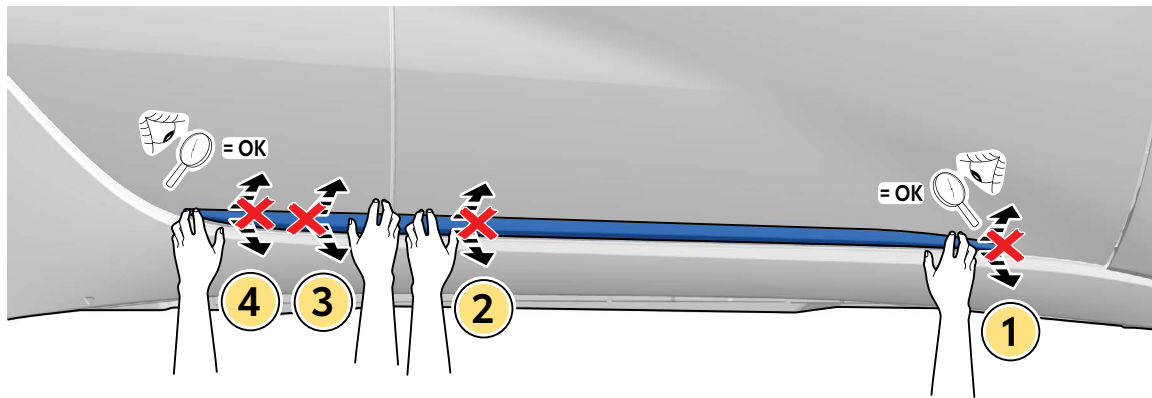

25

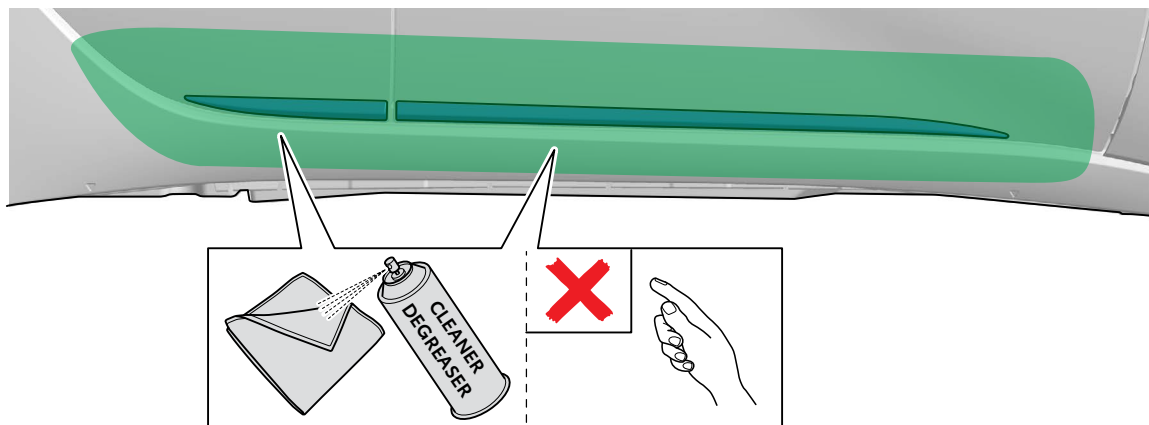

26

INFORMATION

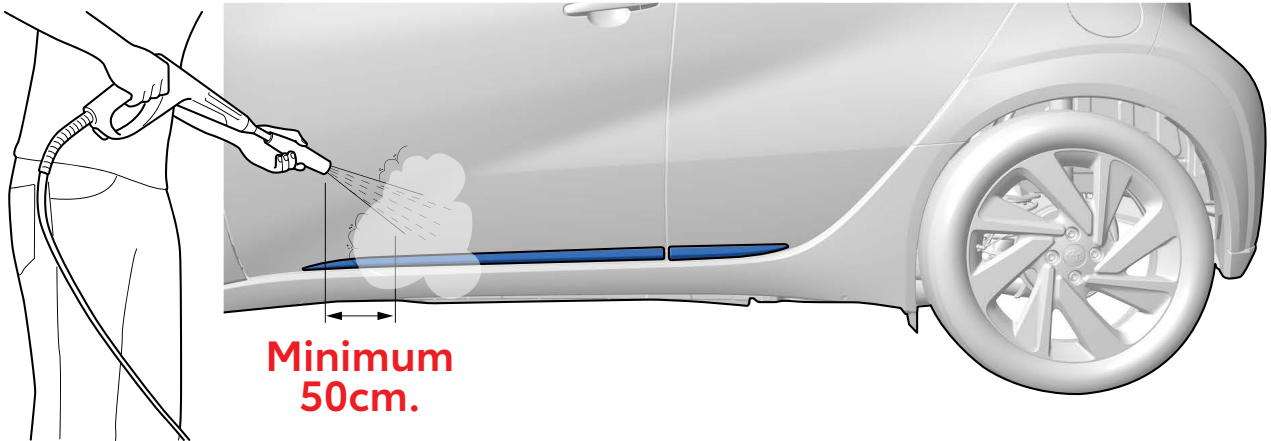
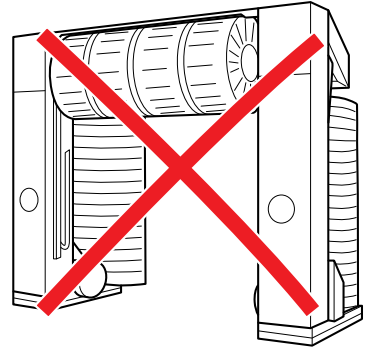
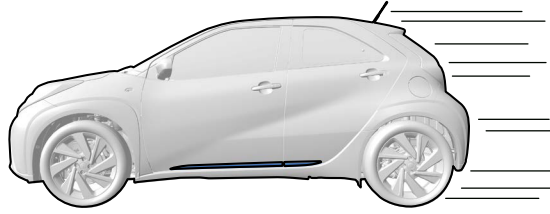
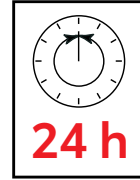
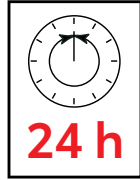
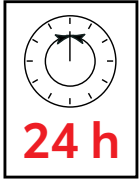

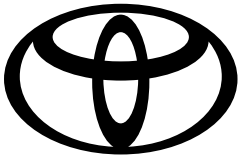

Model/Year

AYGO X
As from 2021/09

Side Sills

VINn°

DURING INSTALLATION

1

OK
P/N = OK

AFTER INSTALLATION

1

A-A
3 mm
4 mm
3 mm
A
A
A
A
A

2

A-A
3 mm
4 mm
3 mm
A
A
A
A
A
C

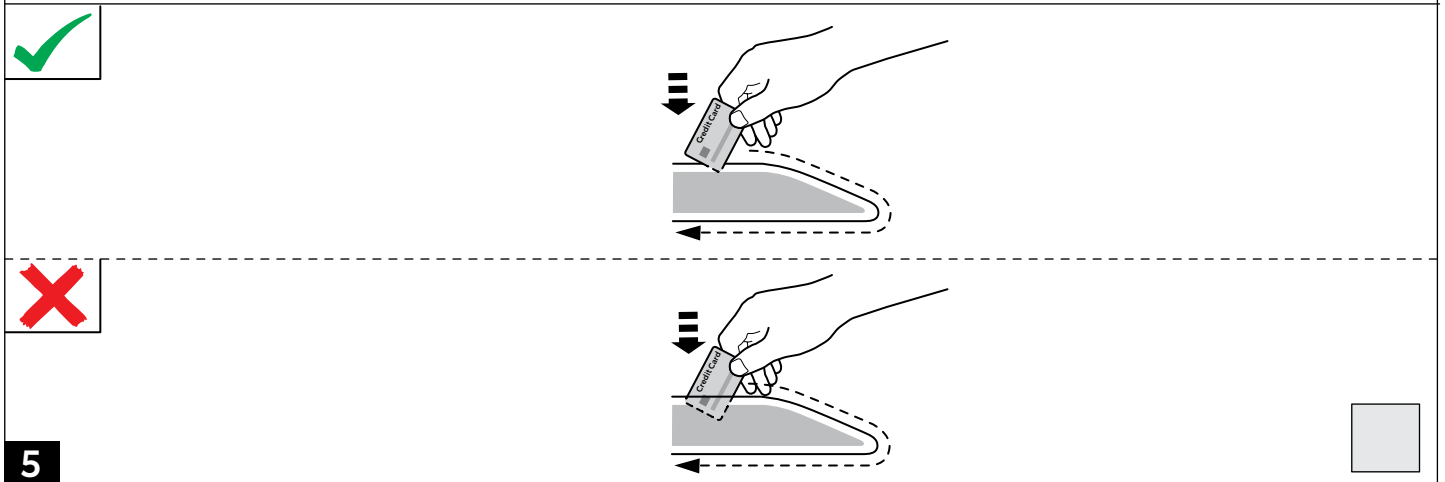
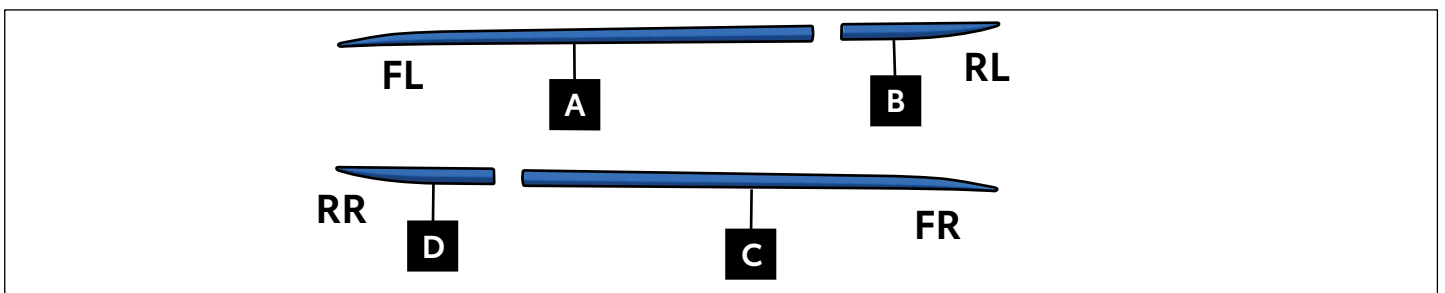
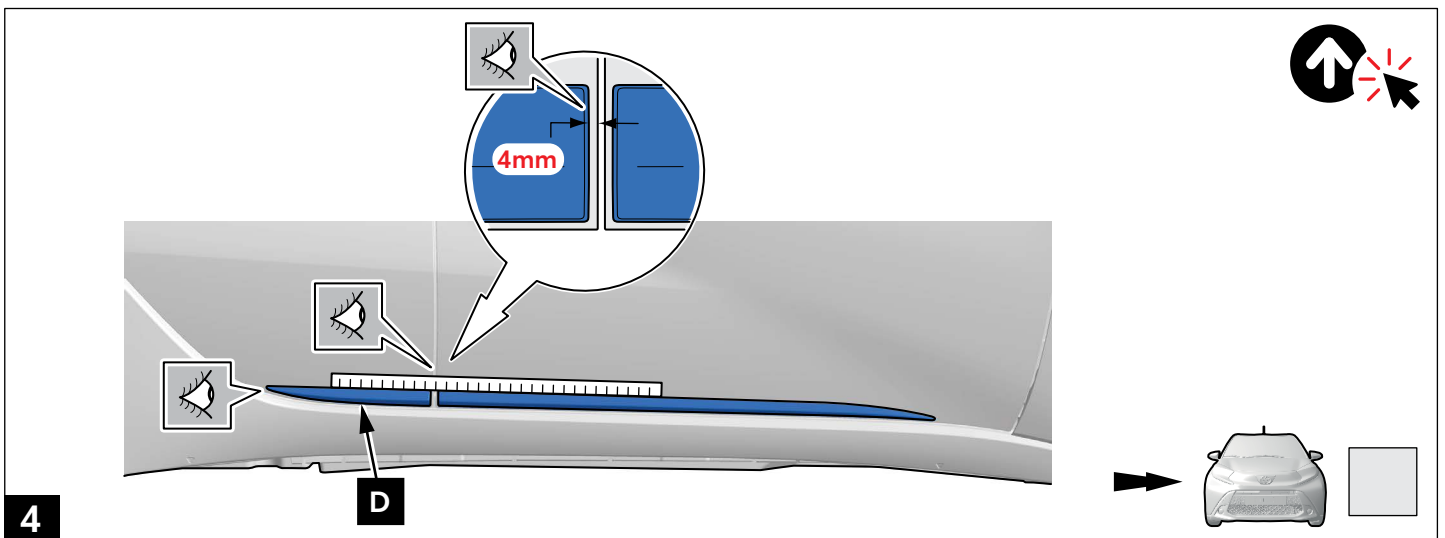
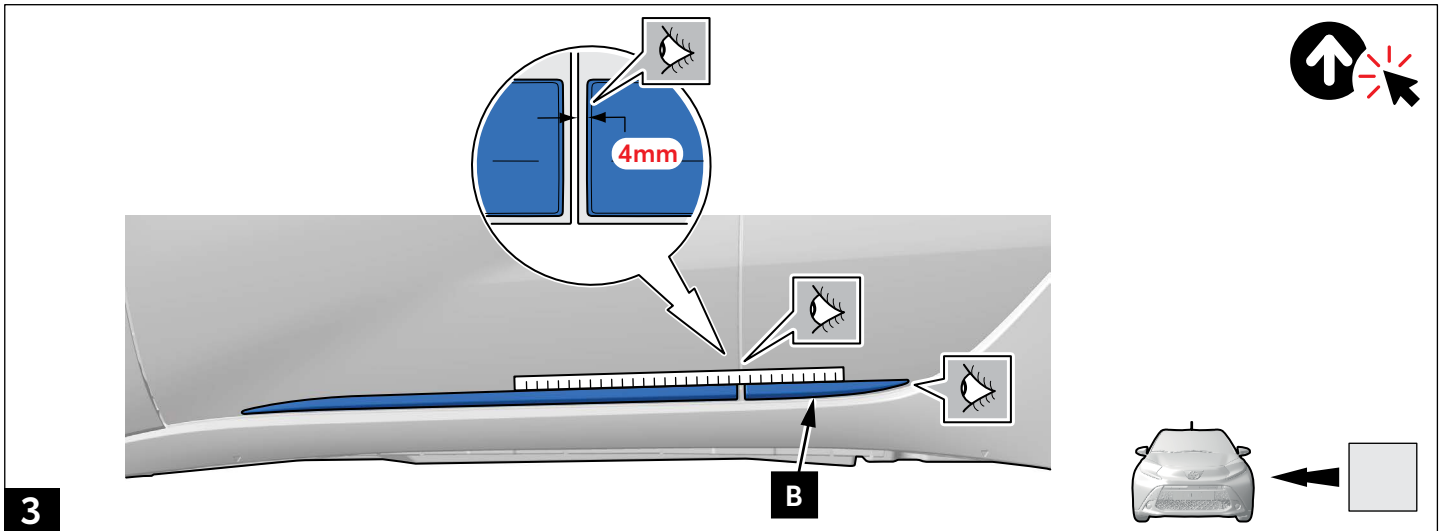

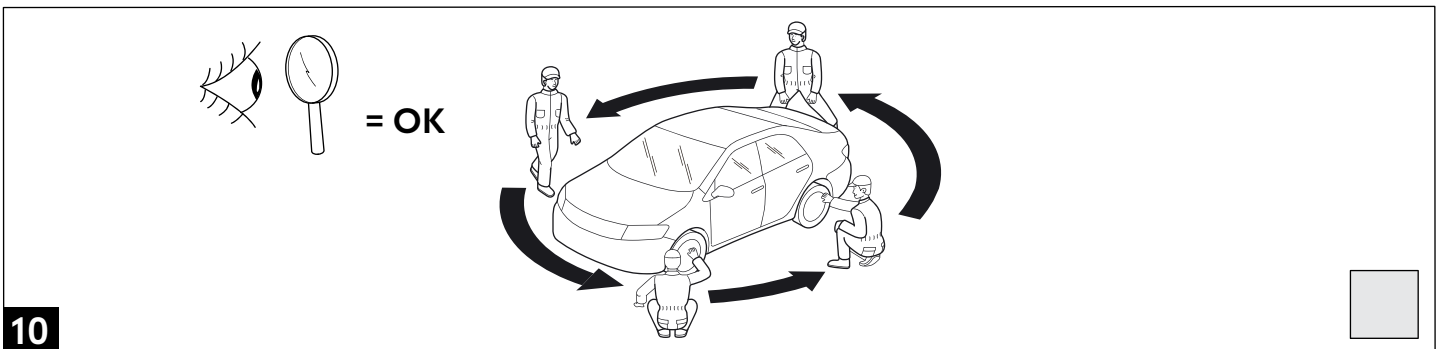
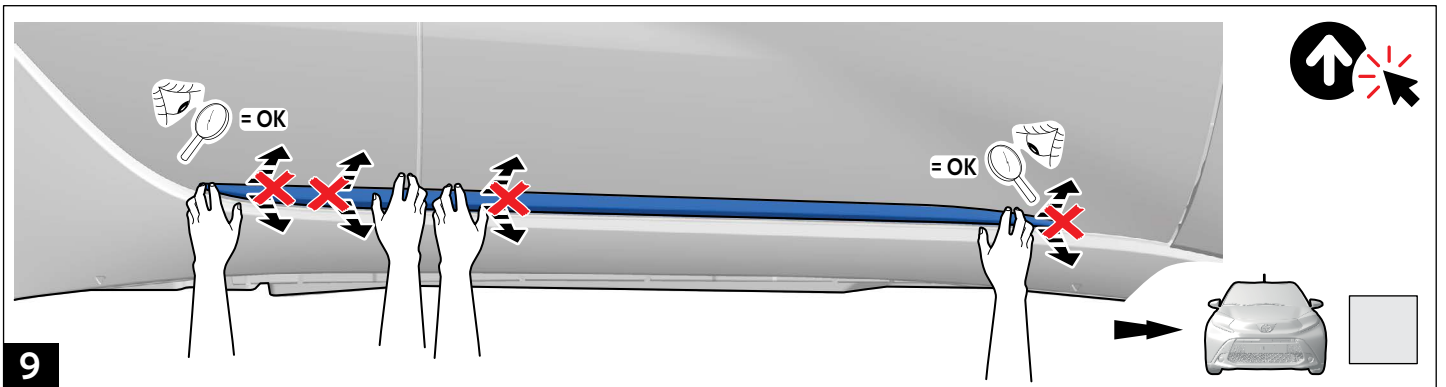
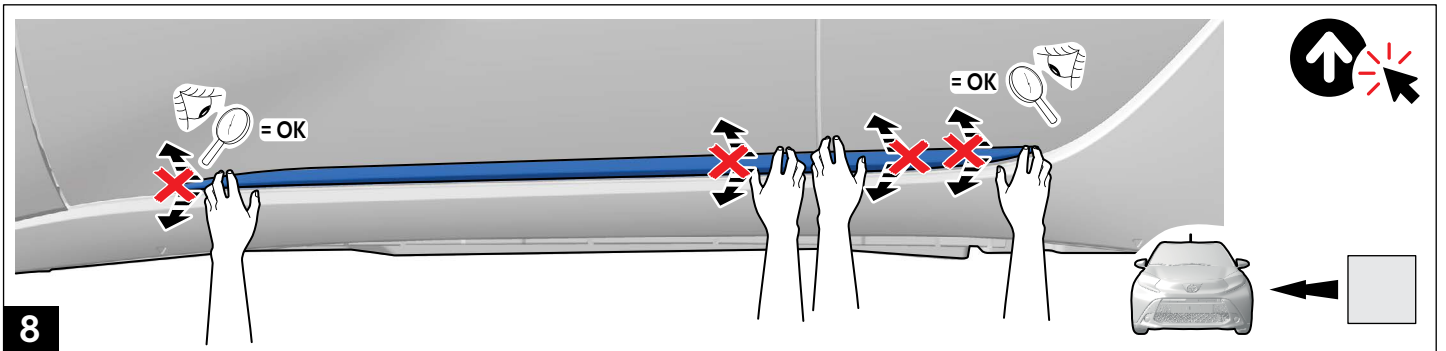
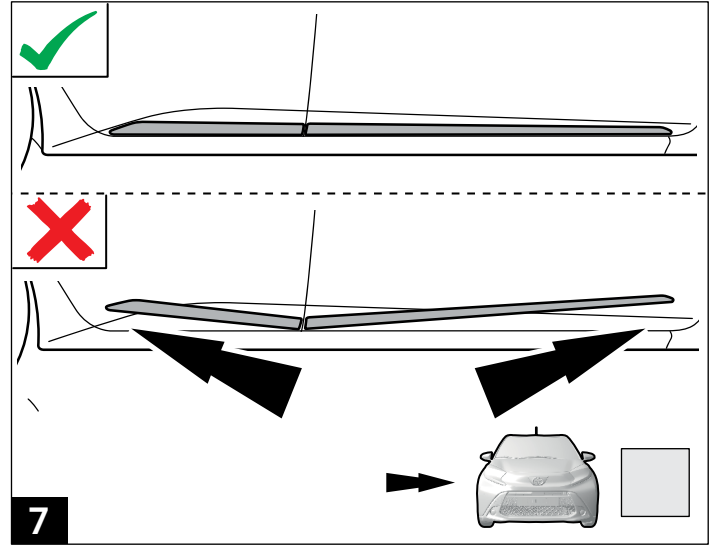
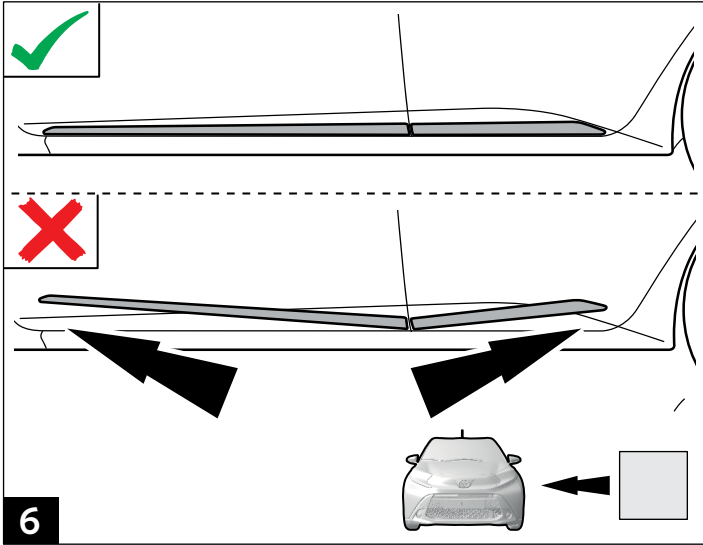

Installation Date:

. . / . . /

Technician Name & Signature:

Stamp: